



Air Conditioning Catalogue 2011

v 1.0

Unit support

Ducting / Trunking

Drainage

Castel Engineering
group

Index

Index	2
Unit support	3
Ducting / Trunking	13
Drainage	24

In this catalogue: New and Special

Roof Inlet
Page 23



NEW

Adjustable Flat Bend
Page 14

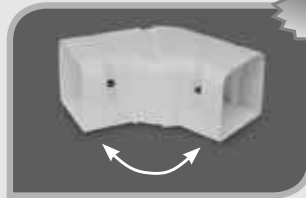

NEW

90° Long Flat Elbow
Page 15



Special

Optimal duct M1
Page 17



M1

Condensation Connect Soft - Rigid 40
Page 31



NEW

Foot Vibration Dampers
Page 09



NEW

Unit Support

Wall Support

Floor Support

Roof Support

Vibration dampers

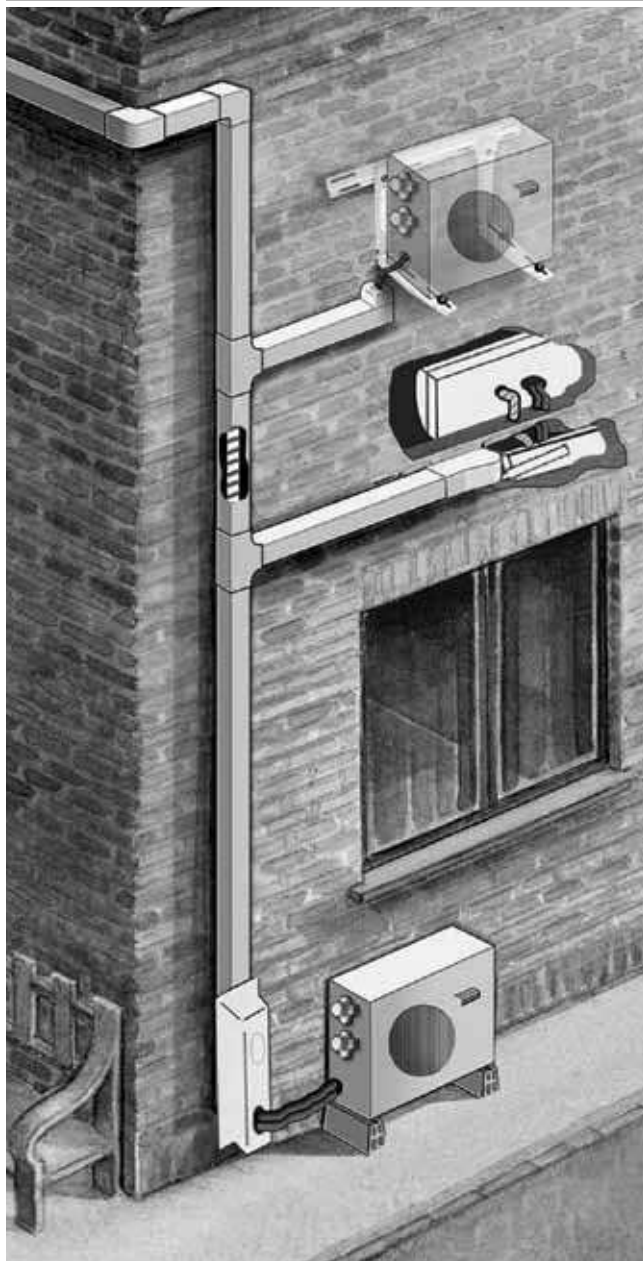

Wall Support

Composite Bracket



SBP46-PUL



SBP46



Optional:
square multipurpose
bubble level tool

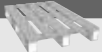

- >> **Recommended for installation in humid and / or salty environments**
- >> Made from composite material
- >> Supplied with a complete assembling kit: wall fixation, stainless steel assembling kit **1**, ivory-white anti-vibration dampers **2** and adjusters for easy levelling on uneven wall surfaces **3**

With Crossbar					
Ref	Horizontal	Vertical	Crossbar	Kg	
SBP46-PUL	460 mm	410 mm	790 mm	80 + 80	98 pcs

Without Crossbar					
Ref	Horizontal	Vertical	Crossbar	Kg	
SBP46	460 mm	410 mm	//////////	80 + 80	98 pcs

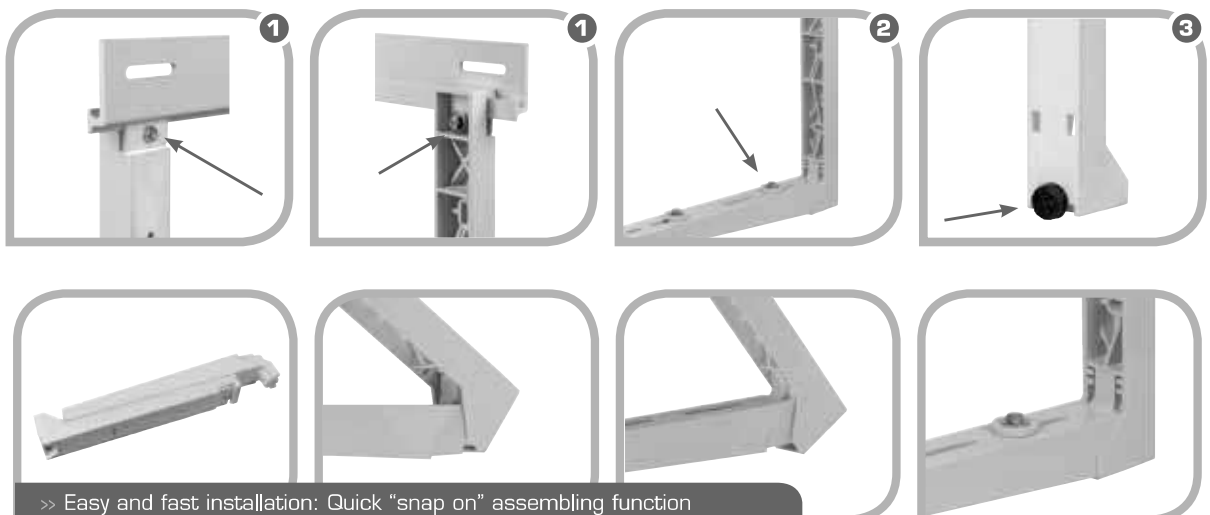

>> Easy and fast installation: Quick "snap on" assembling function

Fast Bracket



Included:
square attachable
multipurpose bubble
level tool

- >> Powder coated RAL 9002
- >> Galvanised steel, thickness 1,5mm
- >> Reinforced assembly
- >> Lateral embossing in both bracket arm parts for extended rigidity

Fast and easy installation

- >> Pre-assembled with 1 screw: just fold the arm open
- >> Supplied with a complete assembling kit: wall fixation kit, anti-vibration dampers with assembling kit and adjusters for easy levelling on uneven wall surfaces
- >> Individual box with clear installation instructions

Ref	Horizontal	Vertical	Crossbar	Kg	
BR01	420 mm	370 mm	780 mm	60 + 60	180 pcs



Wall Support

SBB Bracket

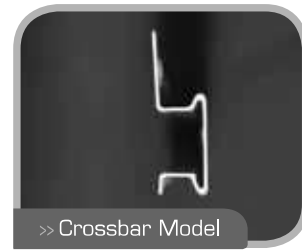

Included:
square attachable
multipurpose bubble
level tool

- >> Powder coated RAL 9002
- >> Galvanised steel, thickness 1,5mm
- >> Reinforced 2 point assembly
- >> Lateral embossing in both bracket arm parts for extended rigidity

Fast and easy installation

- >> Pre-assembled with 1 screw
- >> Supplied with a complete assembling kit: wall fixation kit, anti-vibration dampers with assembling kit and adjusters for easy levelling on uneven wall surfaces
- >> The bracket arm can be fixed to the crossbar thanks to a sliding nut-holder (*)
- >> Clear installation instructions on the individual box.

Ref	Horizontal	Vertical	Crossbar	Kg	
SBB01	450 mm	365 mm	780 mm	70 + 70	144 pcs
SBB03	550 mm	365 mm	780 mm	70 + 70	144 pcs



SBZ Bracket



>> Crossbar Model



Optional:
square attachable
multipurpose bubble
level tool

Improved load and corrosion resistance

- >> Powder coated RAL 9002
- >> Galvanised steel, thickness 1,5mm
- >> Reinforced 2 point assembly
- >> Lateral embossing in both bracket arm parts

Fast and easy installation

- >> Pre-assembled with 1 screw
- >> Supplied with a complete assembling kit: wall fixation kit, anti-vibration dampers with assembling kit and adjusters for easy levelling on uneven wall surfaces

Ref	Horizontal	Vertical	Crossbar	Kg	
SBZ01	450 mm	400 mm	790 mm	75 + 75	98 pcs
SBZ03	530 mm	400 mm	790 mm	100 + 100	98 pcs



>> Adjustable: Composite sliding fixation clamp

Wall support

SBU Bracket

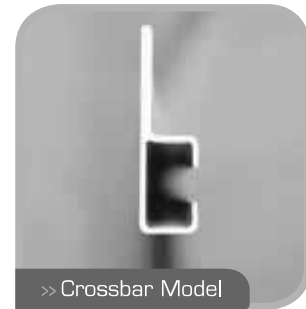

Optional:
square attachable
multipurpose bubble
level tool

Improved load and corrosion resistance

- >> Powder coated RAL 9002
- >> Galvanised steel, thickness 1,5mm
- >> Reinforced 2 point assembly
- >> Lateral embossing in both bracket arm parts

Fast and easy installation

- >> Pre-assembled with 1 screw
- >> Supplied with a complete assembling kit: wall fixation kit, anti-vibration dampers with assembling kit and adjusters for easy levelling on uneven wall surfaces
- >> Crossbar sliding feature

Ref	Horizontal	Vertical	Crossbar	Kg	
SBU01	450 mm	400 mm	790 mm	75 + 75	98 pcs
SBU02	450 mm	400 mm	960 mm	75 + 75	98 pcs
SBU03	530 mm	400 mm	790 mm	100 + 100	98 pcs
SBU04	530 mm	400 mm	960 mm	100 + 100	98 pcs



>> Adjustable: crossbar with 3 fixation point feature and slide-on feature

>> Adjustable: composite sliding fixation clamp reducing noise and vibration transmission

SZ Bracket

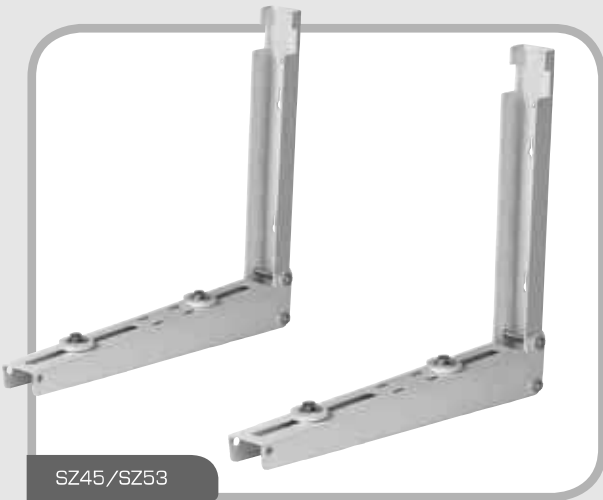

SZ45/SZ53

Wallbrackets without crossbar

- » Pre-assembled with 1 screw
- » Supplied with a complete assembling kit: self-holding anti-vibration dampers with assembling kit and adjusters for easy levelling on uneven wall surfaces



Ref	Horizontal	Vertical	Kg	
SZ45	450 mm	400 mm	75 + 75	98 pcs
SZ53	530 mm	400 mm	100 + 100	98 pcs

Big Vibration Dampers

Foot Vibration Dampers



Cone Shaped: BVDCO

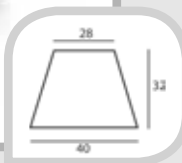

Foot damper: FVDCO

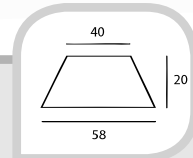

Cylinder Shaped: BVDCY

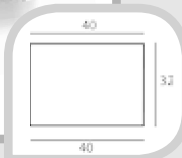

Ref	Kg	Packing	
BVDCO	150 Kg / pc	4 pcs / set	200 pcs (50 sets / box)
BVDCY	150 Kg / pc	4 pcs / set	200 pcs (50 sets / box)
FVDCO	150 Kg / pc	4 pcs / set	200 pcs (50 sets / box)



Special Support

Roof brackets

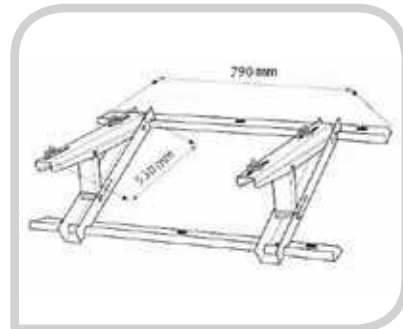

Adjustable for roof slopes between 10° and 40°

- » Galvanized steel, thickness 1,5 mm
- » Powder coated RAL 9002
- » Lateral embossing for enhanced load resistance
- » Improved stability: 2 crossbar based rigid structure

Easy, adjustable and complete

- » Supplied with assembling kit: set of bolts and anti-vibration kit with anti-vibration dampers

Ref	Arm	Crossbar	Kg	
RBZ03	530 mm	790 mm x 2	75 + 75	98 pcs

Floor brackets

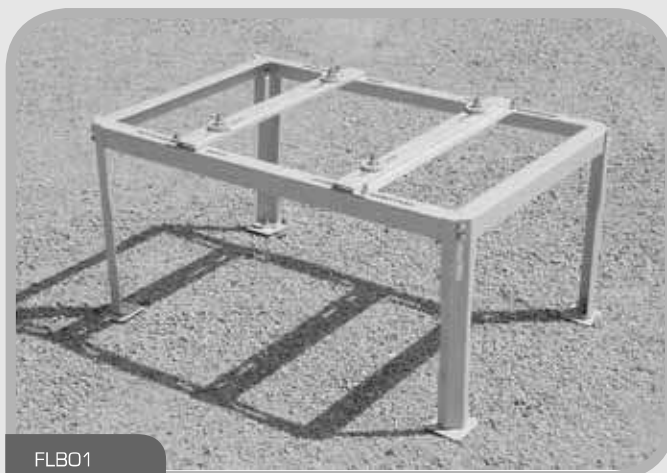

- » Galvanized steel, thickness 1,5 mm
- » Improved stability and load spreading
- » Vertically and horizontally adjustable

Ref	Length	Width	Height (adjustable)	Kg	
FLB01	780 mm	450 mm	300 - 400 mm	50 + 50	144 pcs

Floor Support

Mountblocks



WITH
Anti-slip
Stripes

MOUNTBLOCK "Heavy" 100x100

- » Max. recommended load capacity: 450 Kg per item **
- » Excellent resistance to high (+60°C) and low (-20°C) temperatures
- » Good shock absorption
- » Quick and fast installation
- » Adjustable to all types of units (fixation rail feature)
- » Fixation bolts included
- » Standard colour: white / black
- » With antislip and antivibration stripes

Ref white	Ref. black	Length		
EX.WO38	EX.O38	350 mm	6 x 2 pcs (*)	576 pcs
EX.WB38	EX.B38	450 mm **	6 x 2 pcs (*)	480 pcs
EX.WA38	EX.A38	1000 mm	2 pcs	190 pcs



(*) Wrapped per pair



WITH
Anti-slip
Stripes

MOUNTBLOCK "Light" 100x100

- » Max. recommended load capacity: 200 Kg per item **
- » Excellent resistance to high (+60°C) and low (-20°C) temperatures
- » Quick and fast installation
- » Adjustable to all types of units (fixation rail feature)
- » Fixation bolts included
- » Standard colour: white (* black on request)
- » With anti-slip and antivibration stripes

Ref white	Ref. black	Length		
EX.WO83	EX.O83 *	350 mm	6 x 2 pcs (*)	576 pcs
EX.WC83	EX.C83 *	450 mm **	6 x 2 pcs (*)	480 pcs
EX.WA83	EX.A83 *	1000 mm	2 pcs	190 pcs

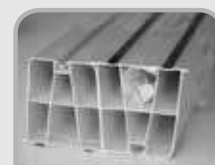

(*) Wrapped per pair



WITH
Anti-slip
Stripes

MOUNTBLOCK "Mini" 80x80

- » Max. recommended load capacity: 200 Kg per item **
- » Excellent resistance to high (+60°C) and low (-20°C) temperatures
- » Quick and fast installation
- » Adjustable to all types of units (fixation rail feature)
- » Fixation bolts included
- » Standard colour: white
- » With antislip and antivibration stripes

Ref	Length		
EX.137	350 mm	6 x 2 pcs (*)	756 pcs
EX.B137	450 mm **	6 x 2 pcs (*)	660 pcs
EX.A137	1000 mm	2 pcs	448 pcs

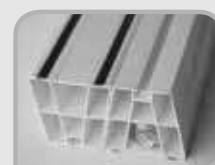

(*) Wrapped per pair

Floor Support

Mountblocks

MOUNTBLOCK ACCESSORIES



INJ.W181



MBM.ECW



A.12

Ref. white	Ref. black	Discription	Packing	
INJ.W181	INJ.181	End cap for mountblock 100x100 (heavy and light)	4 pcs	100 pcs
INJ.437	*	End cap for mountblock 80x80 (mini)	4 pcs	100 pcs

* Contact us

Ref.	Discription	Packing	
A.12	Fixation plate + 2 bolts (only for mountbloccs 100x100)	4 sets	200 pcs

OTHER POSSIBLE APPLICATION:

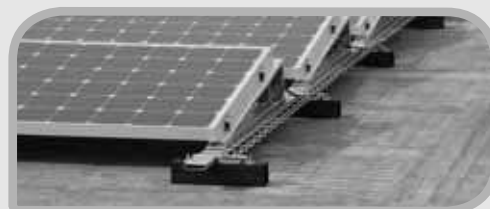

Base Pads



- >> Max. recommended load capacity: 100Kg per item
- >> Features fixation rail + bolts for fast and easy installation
- >> Standard colour: ivory white



Ref.	Length	Height	Width		
CE.BP350	350 mm	78 mm	84 mm	20 pcs	1 120 pcs
CE.BP450	450 mm	78 mm	84 mm	20 pcs	840 pcs

Ducting / Trunking

Airco Ducting

Optimal Ducting

Super Ducting

Eco Ducting

Installation accessories

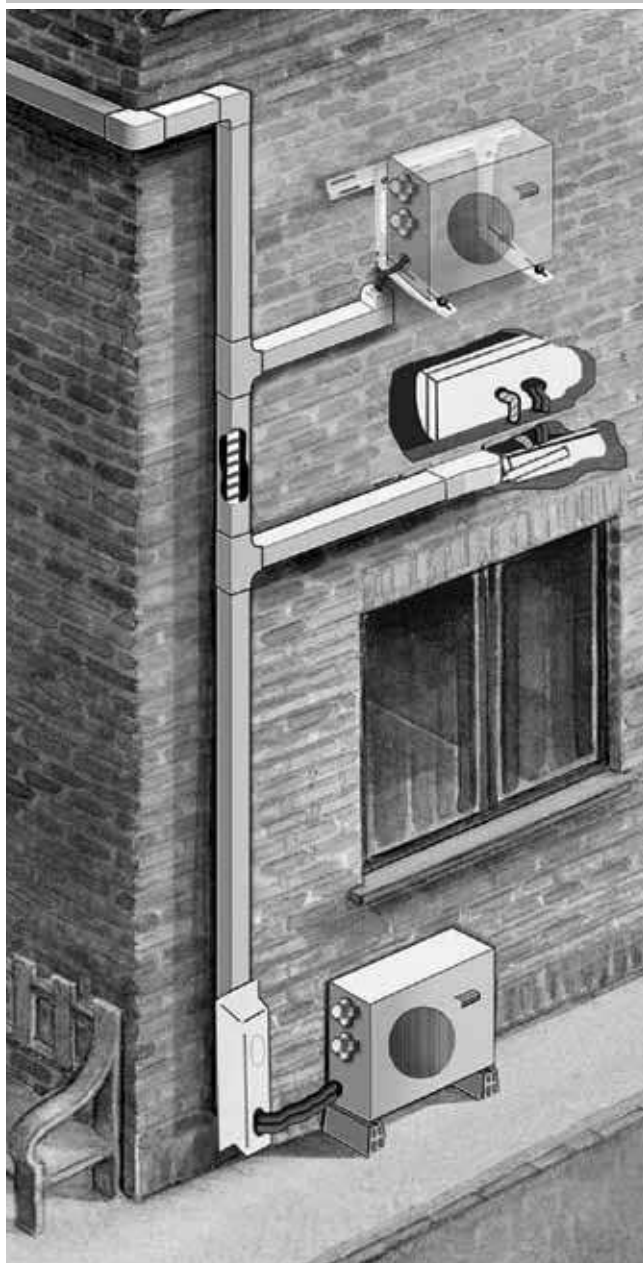

Airco Ducting

Airco Ducts

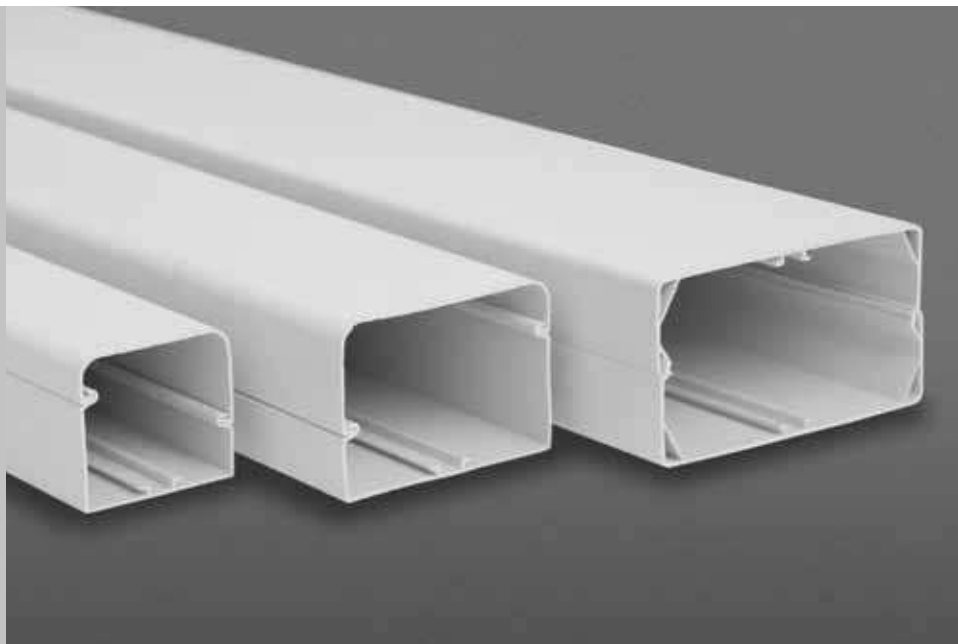

Easy to install

- » The ducts have a bottom and an upper section
- » The bottom is first fixed to the wall
- » Then you fix to the pipe wiring and strap them with the CE.TIE (that slides along the inside rail)
- » Finally cover them with the upper section

Material

- » Made of rigid PVC offering impact resistance
- » The ivory colour is fadeproof / U.V. resistant
- » The ducts are fireproof

Outstanding quality and harmony

Thanks to the advantage of PVC and its linear structure, they are very harmonious with any type of construction or building and can be painted

PAINTABLE



code n°	Struct. Dimensions		Overall Length		
	A	B			
CE.D.70	70 mm	65 mm	2000 mm	6 pcs = 12 lm	432 lm
CE.D.105	105 mm	75 mm	2000 mm	6 pcs = 12 lm	288 lm
CE.D.150	150 mm	80 mm	2000 mm	5 pcs = 10 lm	240 lm

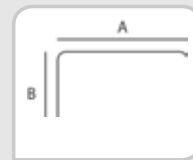

lm = linear meter

ADJUSTABLE FLAT BEND

NEW

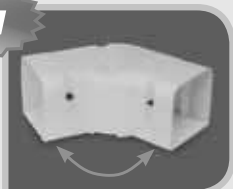

Fixing screws in stainless steel included

REF.

CE.AFB.70	10 pcs
CE.AFB.105	10 pcs



- » Ivory colour / U.V. resistant
- » Packed each separately in plastic film
- » Adjustable flat bend in a range between 45° and 90°

WALL COVER FOR INLET OR OUTLET



Fixing screws in stainless steel included

- >> Ivory colour / U.V. resistant
- >> Packed each separately in plastic film

REF.	
CE.WC.70	10 pcs
CE.WC.105	10 pcs
CE.WC.150	10 pcs

90° FLAT BEND



Fixing screws in stainless steel included

- >> Ivory colour / U.V. resistant
- >> Packed each separately in plastic film

REF.	
CE.FB.70	10 pcs
CE.FB.105	10 pcs
CE.FB.150	10 pcs

90° ELBOW BEND

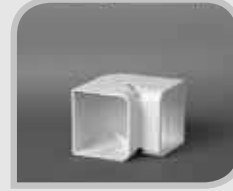

Fixing screws in stainless steel included

- >> Ivory colour / U.V. resistant
- >> Packed each separately in plastic film
- >> To place inside the internal corner

REF.	
CE.EB.70	10 pcs
CE.EB.105	10 pcs
CE.EB.150	10 pcs

90° LONG FLAT ELBOW

Special



- >> Ivory colour / U.V. resistant
- >> Packed each separately in plastic film
- >> Ideal when copper bending is tough (with a wider radius application)

REF.		Fixing screws in stainless steel included
CE.LFB.70	10 pcs	
CE.LFB.105	10 pcs	
CE.LFB.150	10 pcs	

ELBOW BEND 90° CORNER-IN



Fixing screws in stainless steel included

- >> Ivory colour / U.V. resistant
- >> Packed each separately in plastic film
- >> To place around the outside corner

REF.	
CE.EIN.70	10 pcs
CE.EIN.105	10 pcs
CE.EIN.150	10 pcs

45° FLAT BEND



Fixing screws in stainless steel included

- >> Ivory colour / U.V. resistant
- >> Packed each separately in plastic film

REF.	
CE.FB45.70	10 pcs
CE.FB45.105	10 pcs
CE.FB45.150	10 pcs

DUCT END



Fixing screws in stainless steel included

- >> Ivory colour / U.V. resistant
- >> Packed each separately in plastic film

REF.	
CE.DE.70	10 pcs
CE.DE.105	10 pcs
CE.DE.150	10 pcs

DUCT CAP



- >> Ivory colour / U.V. resistant

REF.	
CE.DC.70	10 pcs
CE.DC.105	10 pcs
CE.DC.150	10 pcs

CONNECTION PIECE



Fixing screws in stainless steel included

- >> Ivory colour / U.V. resistant
- >> Packed each separately in plastic film

REF.	
CE.CP.70	10 pcs
CE.CP.105	10 pcs
CE.CP.150	10 pcs

Airco Ducting

Airco Duct Accessories

REDUCER JOINT



Fixing screws in stainless steel included

- » Ivory colour / U.V. resistant
- » To connect a CE.D. 70 duct to a CE.D. 105 duct or a CE.D105 to a CE.D150 and reversely
- » To connect a CE.D. 70 duct to a T-joint CE.TJ. 105 or a CE.D.105 to a T-joint CE.TJ.150

REF.	
CE.RJ.70.105	10 pcs
CE.RJ.105.150	10 pcs

T-JOINT



Fixing screws in stainless steel included

- » Extremely useful in case of multi-split
- » System to combine Duct 70 mm with Duct 150 mm or Duct 150 mm with Duct 105 mm (needs a CE.RJ)
- » Ivory colour / U.V. resistant
- » Packed each separately in plastic film

REF.	
CE.TJ.105	10 pcs
CE.TJ.150	10 pcs

FLAT ROSETTE



- » Ivory colour / U.V. resistant
- » Packed each separately in plastic film

REF.	
CE.FR. 70	10 pcs
CE.FR.105	10 pcs
CE.FR.150	10 pcs

WALL ROSETTE



- » Ivory colour / U.V. resistant
- » Packed each separately in plastic film

REF.	
CE.WR.70	10 pcs
CE.WR.105	10 pcs
CE.WR.150	10 pcs

FLEX JOINT



- » Ivory colour / U.V. resistant
- » Packed each separately in plastic film

REF.	
A.FJ.70	10 pcs
A.FJ.105	10 pcs

TIE CLIP



- » Slides into the fixation rail inside the ducts
- » Very useful to keep the tubing in place during installation
- » Time and money saver

REF.	pcs/pack
CE.TCLIP	100 pcs

Optimal Ducting

Optimal Ducts

M1

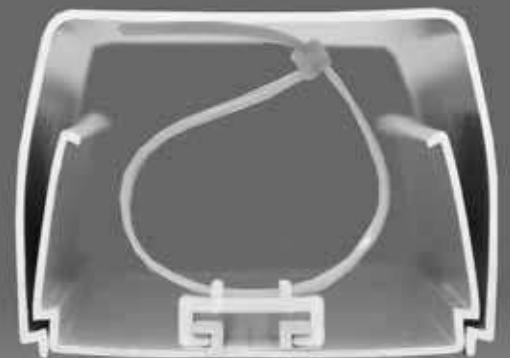

Attractive compact trunking that protects the insulated tubing. It contributes to energy saving and no-worry long-lasting working of your split installation.

OD80, OD90, OD110 sizes

Technical Data

- >> Material: rigid, M1 fire-resistant, shockproof PVC, UV-stabilized
- >> Colour: white (RAL 9003)
- >> Improved resistance to high (+60°C) and low (-20°C) temperatures
- >> Available sizes: 60x40mm, 80x60mm*, 90x65mm*, 110x75mm* (l x h)
- >> [*] with fixation rail

REF.	STRUCTURAL DIMENSIONS		LENGTH (mm)		
	l (mm)	h (mm)			
OD.60	60 mm	40 mm	2000 mm	24 lm	864 lm
OD.80	80 mm	60 mm	2000 mm	16 lm	384 lm
OD.90	90 mm	65 mm	2000 mm	16 lm	288 lm
OD.110	110 mm	75 mm	2000 mm	8 lm	256 lm

WITH PROTECTION FILM



All the optimal ducts have a protection film

Optimal Duct Clamp

Tie Clip



The Optimal Clamp is a useful fastening accessory that allows the installer to fasten and block the tubing inside the trunking. It's very quick, you just have to click it inside the base profile.

It improves the rigidity of the whole ducting installation.

NEW! FIXATION RAIL



[*] The Optimal duct OD80, OD90 and OD110 are provided with a fixa-

REF.	COLOUR	Packing
ODCL.60	yellow	12 pcs
ODCL.80	red	12 pcs
ODCL.90	blue	12 pcs
ODCL.110	green	12 pcs

The "Click-In" / "Snap-On" fitting system provides a quick and rigid assembly.

Optimal / Super Duct

Optimal / Super Duct Accessories

All accessories for Optimal duct and Super duct are interchangeable, except ODCL and SDCL.

FLAT ELBOW 90°



REF.	
ODFE.60	10 pcs
ODFE.80	10 pcs
ODFE.90	10 pcs
ODFE.110	10 pcs

IN-CORNER 90°



REF.	
ODIC.60	10 pcs
ODIC.80	10 pcs
ODIC.90	10 pcs
ODIC.110	10 pcs

CORNER OUT 90°



REF.	
ODOC.60	10 pcs
ODOC.80	10 pcs
ODOC.90	10 pcs
ODOC.110	10 pcs

T-JUNCTION



REF.	
ODTJ.80	10 pcs
ODTJ.110	10 pcs

REDUCER



REF.	
ODRJ.80-60	10 pcs
ODRJ.110-80	10 pcs
ODRJ.110-90	10 pcs

CONNECT



REF.	
ODC.60	10 pcs
ODC.80	10 pcs
ODC.90	10 pcs
ODC.110	10 pcs

WALL ROSETTE



REF.	
ODWR.60	10 pcs
ODWR.80	10 pcs
ODWR.90	10 pcs
ODWR.110	10 pcs

WALL COVER



REF.	
ODWC.60	10 pcs
ODWC.80	10 pcs
ODWC.90	10 pcs
ODWC.110	10 pcs

END CAP



REF.	
ODEC.60	10 pcs
ODEC.80	10 pcs
ODEC.90	10 pcs
ODEC.110	10 pcs

Super Ducting

Super Ducts

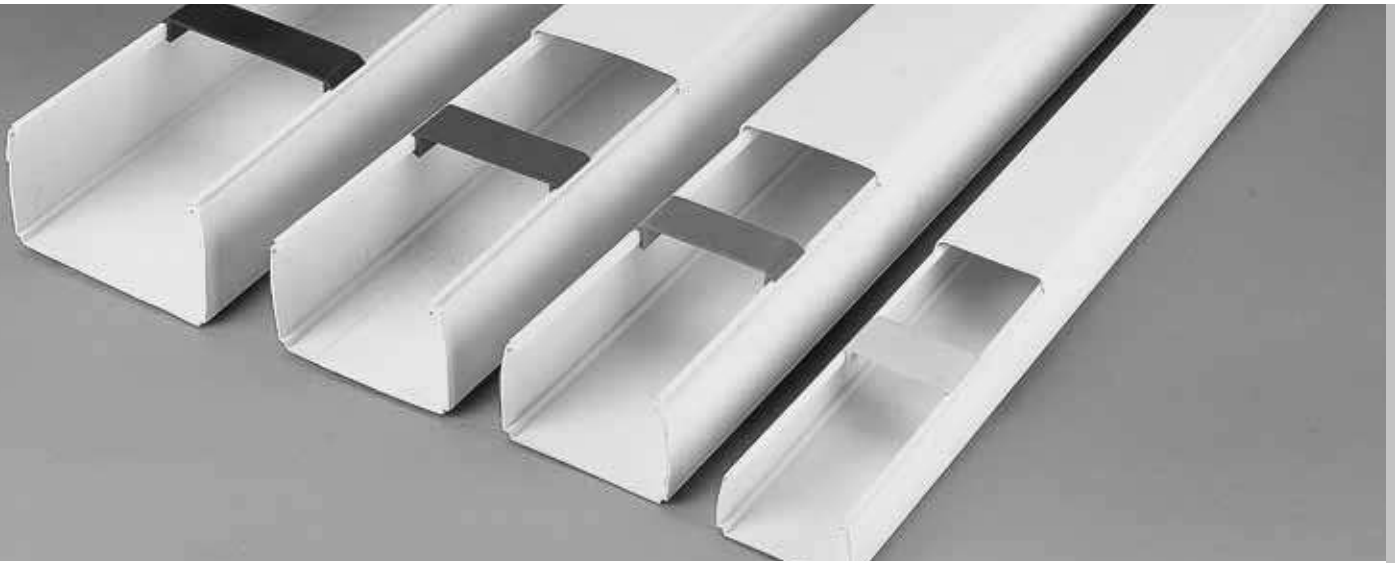

Technical Data

- » Material: rigid, fire-resistant, shockproof PVC and UV-stabilized
- » Colour: white (RAL 9003)
- » Improved resistance to high (+60°C) and low (-20°C) temperatures
- » Available sizes: 60 x 40 mm, 80 x 60 mm, 90 x 65 mm, 110 x 75 mm (l x h)

REF.	STRUCTURAL DIMENSIONS		LENGTH (mm)		
	l (mm)	h (mm)			
SD.60	60 mm	40 mm	2000 mm	24 lm	1344 lm
SD.80	80 mm	60 mm	2000 mm	16 lm	640 lm
SD.90	90 mm	65 mm	2000 mm	16 lm	650 lm
SD.110	110 mm	75 mm	2000 mm	8 lm	256 lm

Attractive compact trunking that protects the insulated tubing. It contributes to energy saving and no-worry long-lasting working of your split installation.

Super Duct Clamp

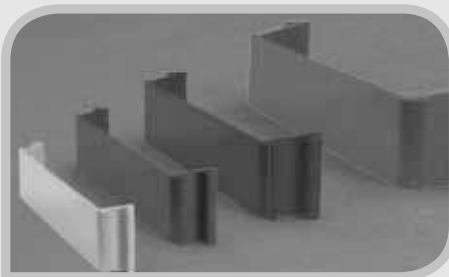

The Super Clamp is a useful fastening accessory that allows the installer to fasten and block the tubing inside the trunking. It's very quick, you just have to click it inside the base profile.

It improves the rigidity of the whole ducting installation.

The "Click-In" / "Snap-On" fitting system provides a quick and rigid assembly.

REF.	COLOUR	Packing
SDCL.60	yellow	12 pcs
SDCL.80	red	12 pcs
SDCL.90	blue	12 pcs
SDCL.110	green	12 pcs

Optimal / Super Duct

Optimal / Super Duct Accessories

All accessories for Optimal duct and Super duct are interchangeable, except ODCL and SDCL.

FLAT ELBOW 90°



REF.	
ODFE.60	10 pcs
ODFE.80	10 pcs
ODFE.90	10 pcs
ODFE.110	10 pcs

IN-CORNER 90°



REF.	
ODIC.60	10 pcs
ODIC.80	10 pcs
ODIC.90	10 pcs
ODIC.110	10 pcs

CORNER OUT 90°



REF.	
ODOC.60	10 pcs
ODOC.80	10 pcs
ODOC.90	10 pcs
ODOC.110	10 pcs

T-JUNCTION



REF.	
ODTJ.80	10 pcs
ODTJ.110	10 pcs

REDUCER



REF.	
ODRJ.80-60	10 pcs
ODRJ.110-80	10 pcs
ODRJ.110-90	10 pcs

CONNECT



REF.	
ODC.60	10 pcs
ODC.80	10 pcs
ODC.90	10 pcs
ODC.110	10 pcs

WALL ROSETTE



REF.	
ODWR.60	10 pcs
ODWR.80	10 pcs
ODWR.90	10 pcs
ODWR.110	10 pcs

WALL COVER



REF.	
ODWC.60	10 pcs
ODWC.80	10 pcs
ODWC.90	10 pcs
ODWC.110	10 pcs

END CAP



REF.	
ODEC.60	10 pcs
ODEC.80	10 pcs
ODEC.90	10 pcs
ODEC.110	10 pcs

Eco Ducting

Eco Ducts

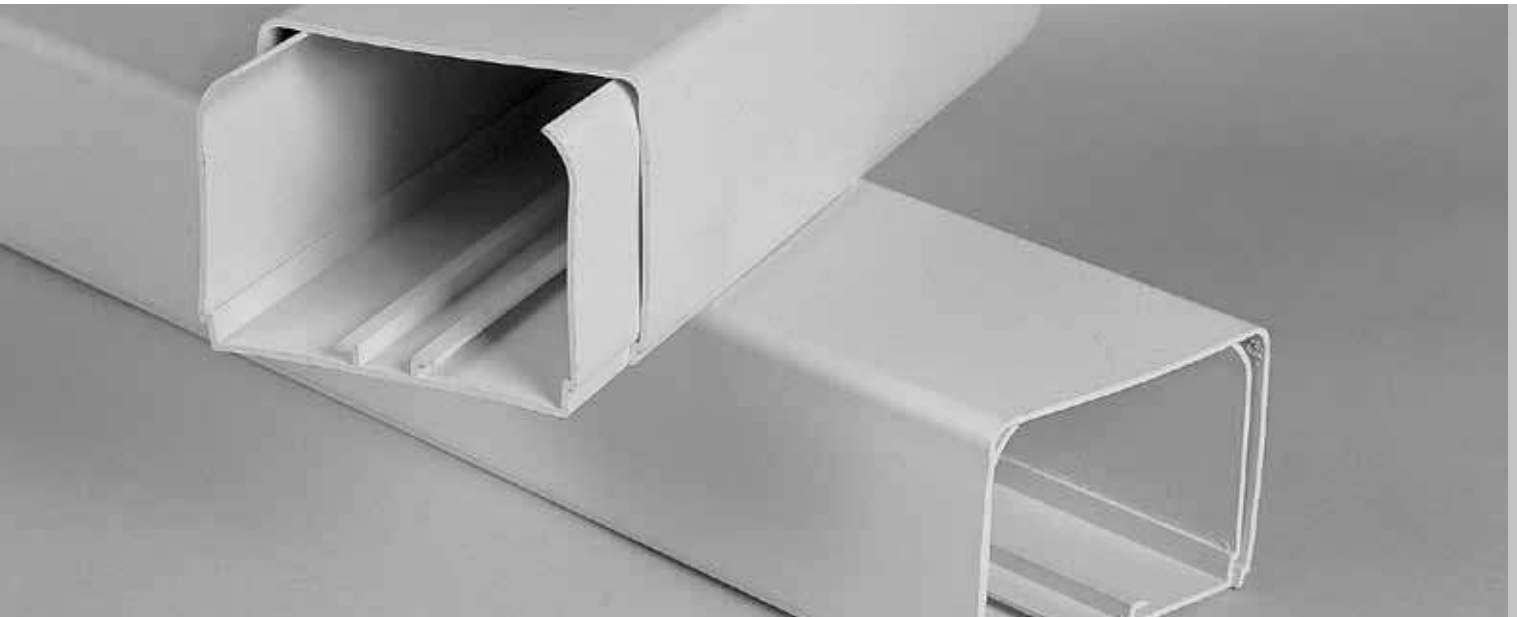

Installation

The Eco Duct consists of 2 separate parts: The base (EDB) and the cover (EDC). You first fix the base (EDB) onto the wall, then fix the pipes or with the help of Tie Clips (CE.TCLIP) and finally you put the cover (EDC) onto the base.



Material

Made of rigid PVC and produced in ivory colour, the Eco Duct is fadeproof (resists to UV-rays and to colour alternations). Due to its design, it looks nice and matches well in whatever indoor / outdoor environment the Eco duct Line components are installed.

Colour: white (RAL 9002)

For multiple applications

The composition and dimensions have been carefully studied in order to suit any kind of domestic application. You can use our Eco Duct Line to hold: air conditioning or plumbing pipes, network wiring.

REF.	A	B	C		
ECO D.80	80 mm	60 mm	74 mm	20 lm	360 lm
ECO D.105	105 mm	60 mm	99 mm	20 lm	300lm

Code: EDB (base) EDC (cover)

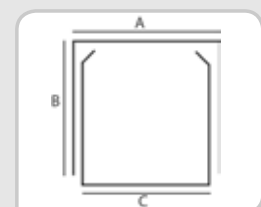

Eco Ducting

Eco Duct Accessories

ECO WALL COVER



>> Ivory colour / U.V. resistant

REF.	
EWC.80	20 pcs
EWC.105	20 pcs

ECO CAP



>> Ivory colour / U.V. resistant

REF.	
ECAP.80	20 pcs
ECAP.105	20 pcs

ECO CONNECT



>> Ivory colour / U.V. resistant

REF.	
ECON.80	20 pcs
ECON.105	20 pcs

ECO CORNER-IN



>> Ivory colour / U.V. resistant

REF.	
ECL.80	20 pcs
ECL.105	20 pcs

ECO CORNER-OUT



>> Ivory colour / U.V. resistant

REF.	
ECO.80	20 pcs
ECO.105	20 pcs

ECO FLAT ELBOW

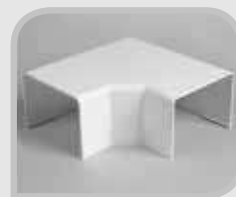

>> Ivory colour / U.V. resistant

REF.	
EFE.80	20 pcs
EFE.105	20 pcs

ECO T-JUNCTION



>> Ivory colour / U.V. resistant

REF.	
ETJ.80	20 pcs
ETJ.105	20 pcs

THE TIE



>> Slides into the fixation rail inside the ducts
>> Very useful to keep in place the tubing during installation

REF.	packing
CE.TCLIP	100 pcs

Installation Accessories

Useful Installation Accessories

Roof Inlet

NEW



- >> To cover the hole on the roof made to pass through linesets (e.g. insulated copper tubes), that are connected to an outdoor unit
- >> RAL 9002
- >> high thermal stability
- >> good chemical resistance
- >> excellent resistance to weathering, ageing and yellowing.

REF.	Measurements	packing BOX	Packing PAL
RFI.125	125 x 250 mm	2 pcs	60 pcs
RFI.250	250 x 250 mm	2 pcs	40 pcs

BIG TIE CLIP



REF.	length	packing
CE.TC.25	250 mm	20 pcs
CE.TC.35	350 mm	20 pcs

COVER FOR REFRIGERATION VALVES

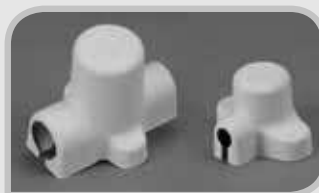

REF.	Packing
CGT big + small	10 pairs = 20 pcs

- >> Cover for refrigeration valves
- >> By set of 1/2 + 1/4 inch covers
- >> Ensures protection of the valves
- >> On request also available in black colour

WALL SLEEVE

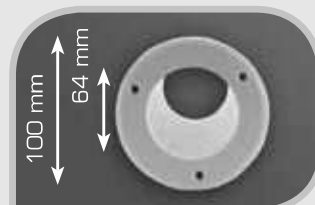

- >> Protects the copper tubes and the insulation from damage during the installation
- >> Provides fast "pass through" and nice final touch inside
- >> Adjustable to the wall thickness
- >> The hole should be made with a drill of 64 mm or 2,5 inch Ø

REF.	15 pcs	900 pcs
WSLV		

Drainage

Trays

Pre-installation

Drain Pipes

Rigid Drain Pipes

Drain Pipe Ducting

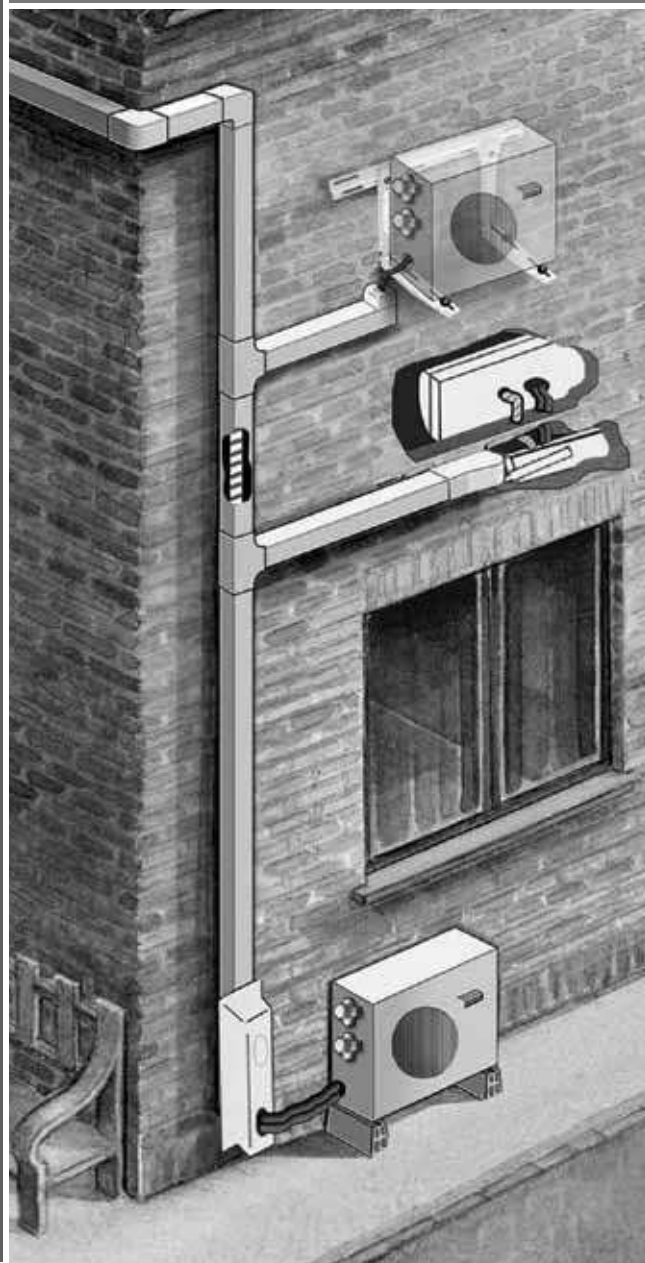

Drain Pans / Trays



100% RUST
FREE

TRAY FOR THE COLLECTION OF CONDENSATION WATER

- » Made of strong and rigid plastic. 100% rust free
- » Adjustable to any kind of bracket
- » Embedded water outlet of \varnothing 16 mm, \varnothing 18 mm and \varnothing 20 mm
- » The 2 hang supports are made of glass fibre reinforced plastic and are 100% rust free
- » Inside tray surface is slightly conical to lead the water to the outlet

REF.	Length	Width		
TCCW.94	940 mm	420 mm	10 pcs	100 pcs
TCCW.79	790 mm	390 mm	9 pcs	162 pcs
TCCW.94 INDIV	940 mm	420 mm	1 pcs	70 pcs
TCCW.79 INDIV	790 mm	390 mm	1 pcs	75 pcs

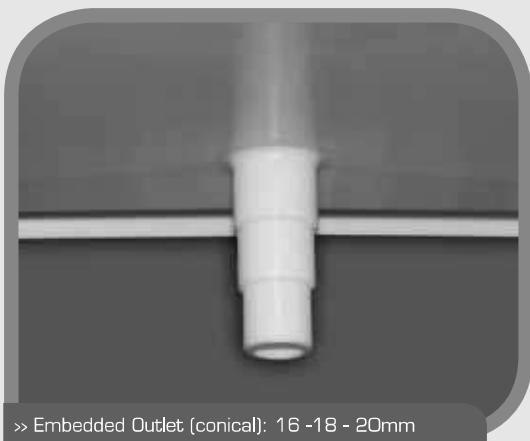

» Embedded Outlet (conical): 16 -18 - 20mm

Pre-installation

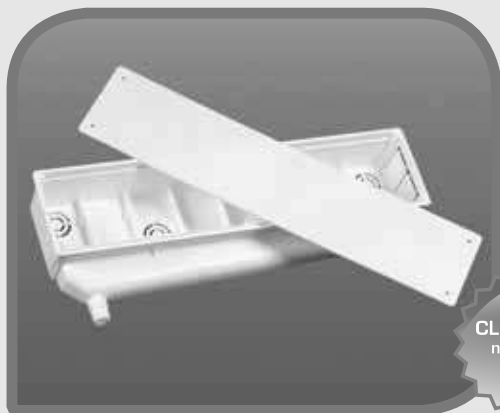

With Vertical Outlet



CLIP-ON LID
no screws
needed

BOXES WITH VERTICAL OUTLET LEFT / RIGHT

- >> Built-in box for pre-installation of air conditioning systems
- >> Connections for Ø16mm, Ø18mm and Ø20mm drain pipes

REF.		
E-BOX VO	20 pcs	600 pcs
E-BOX SVO*	20 pcs	600 pcs
E-BOX BVO	20 pcs	480 pcs

* available on request

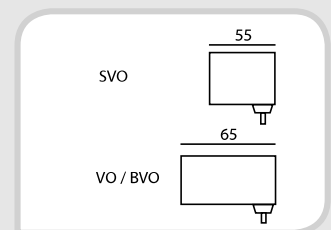
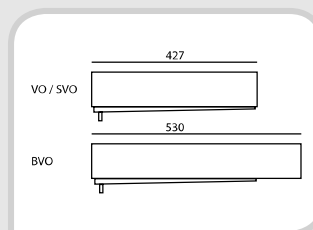



With Horizontal Outlet



CLIP-ON LID
no screws
needed

BOXES WITH HORIZONTAL OUTLET LEFT / RIGHT

- >> Built-in box for pre-installation of air conditioning systems
- >> Connections for Ø16mm, Ø18mm and Ø20mm drain pipes

REF.		
E-BOX HO	20 pcs	500 pcs
E-BOX SHO*	20 pcs	500 pcs
E-BOX BHO	20 pcs	480 pcs

* available on request

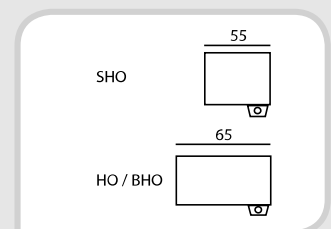
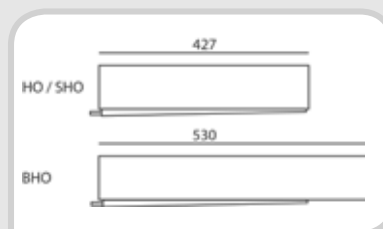

Pre-installation

Closed

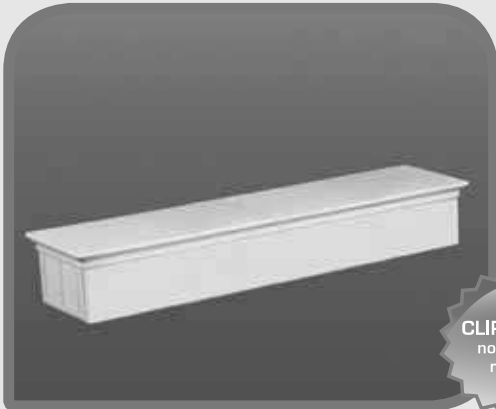

CLIP-ON LID
no screws
needed

>> Built-in box for pre-installation of air conditioning systems

REF.		
E-BOX CL	20 pcs	600 pcs
E-BOX SCL*	20 pcs	600 pcs

* available only on request

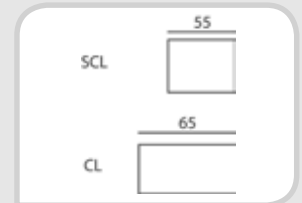
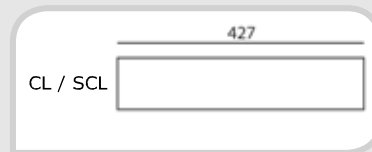



External Box

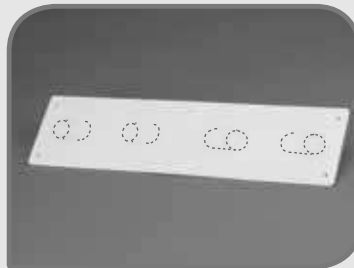

>> Can be used both ways: "fit in" (1) or "fit on" (2)
>> Cut out marks foreseen



REF.	A	B	C		
EXT-BOX	708 mm	165 mm	75 mm	10 pcs	180 pcs
EXT-LID	715 mm	160 mm	////////	100 pcs	////////



(1)



(2)

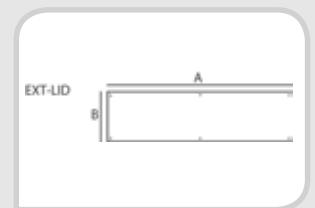
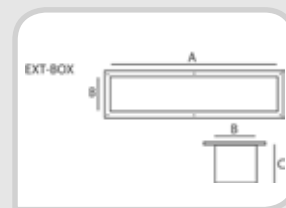

Pre-installation

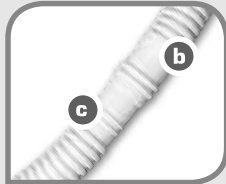

Drain Pipes

DRAIN PIPE



UV RESISTANT

- » Ivory white colour
- » By hose of 50 m in a carton box
- » With regular cutmarks
- » Connects to Ø16, Ø18 and Ø20 systems

REF.	B	C		
A.DP.93	16	18	50 m	90 rolls
A.DP.94	18	20	50 m	90 rolls



B and C sizes are expressed in mm

DRAIN PIPE SMOOTH INSIDE



UV RESISTANT

- » Ivory / white colour
- » By hose of 30 m
- » Available for Ø16 and Ø20 systems

REF.	Ø		
A.DPS.16	16	30 m	144 rolls
A.DPS.20	20	30 m	108 rolls

Transparent Tube



REF.	Diameter outside	Diameter inside	Packing	
A.DPT.95	9 mm	6 mm	50 m	100 rolls/pal

Condensation Connection Y

REGULAR

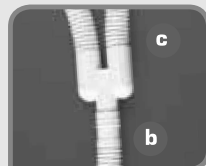

UV RESISTANT

- » Ivory / white colour
- » To connect A.DP.93 / A.DP.94 drain pipes
- » Useful in case of multi-split

REF.	B	C		
A.CCY	Ø16, Ø18, Ø20	Ø16	20 pcs	1000 pcs

SMOOTH



- » Transparent colour
- » To connect A.DPS.16 / A.DPS.20 drain pipes
- » Useful in case of multi-split

REF.	Ø	Packing
CCSY	Ø16, Ø18, Ø20	20 pcs

Drain Pipe Ducts

Drain Pipe Ducts

DRAIN PIPE DUCTS

- 1 DRAIN PIPE DUCT
- 2 DRAIN PIPE DUCT CORNER-IN
- 3 DRAIN PIPE CORNER-OUT
- 4 DRAIN PIPE FLAT ELBOW
- 5 DRAIN PIPE CONNECTOR
- 6 DRAIN PIPE WALL CONNECTOR

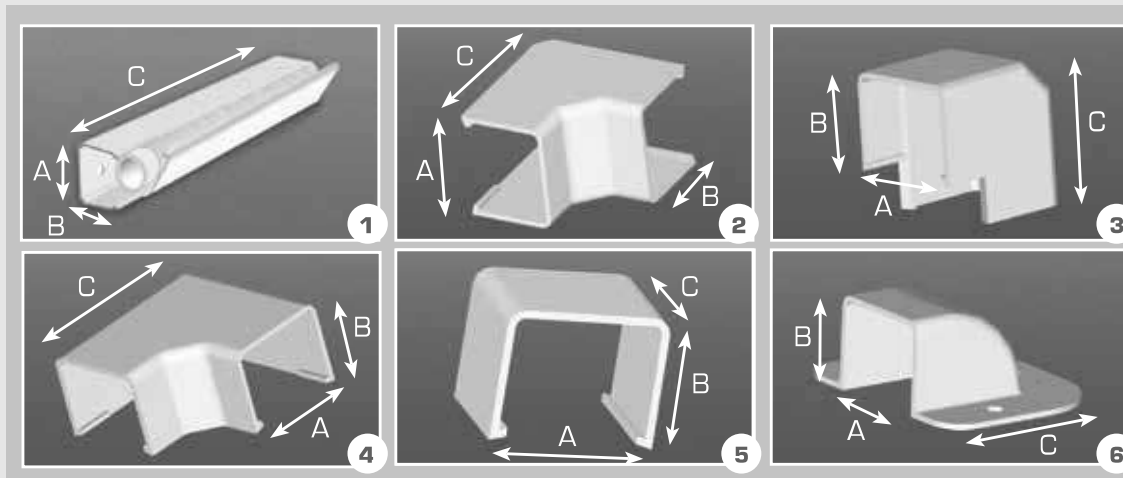

	REF.	A	B	C	Packing	Big Packing
1	DPD	32 mm	30 mm	2000 mm	64 lm	1536 lm
2	DPCI	35 mm	32 mm	57 mm	20 pcs	280 pcs
3	DPCO	35 mm	32 mm	47 mm	20 pcs	480 pcs
4	DPFE	35 mm	32 mm	65 mm	20 pcs	260 pcs
5	DPC	35 mm	32 mm	30 mm	20 pcs	1200 pcs
6	DPWC	35 mm	32 mm	63 mm	20 pcs	180 pcs

Rigid Drain Pipes

Rigid Drain Pipe

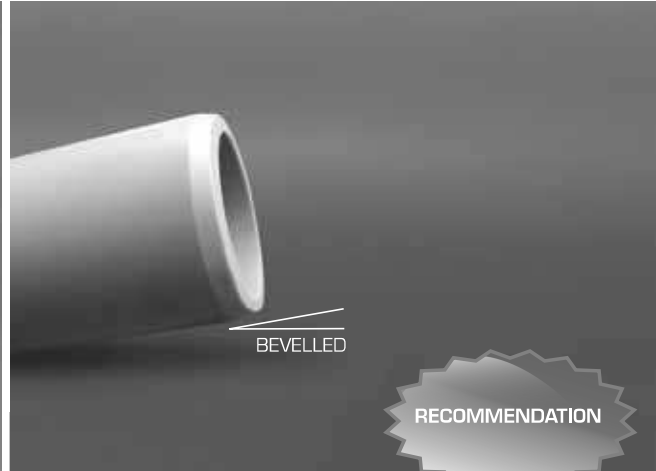
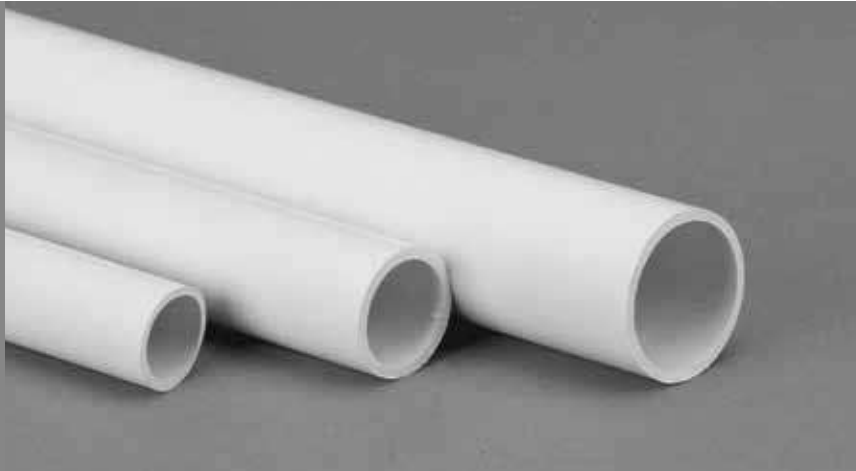

- >> Made of rigid PVC
- >> Self-extinguishing
- >> We recommend to use this pipe for water without any pressure



Rigid drain pipe should be bevelled before inserting them into a connection accessory

REF.	Ø OUTER	LENGTH	Packing BAG	Packing PAL
RDP.20	20 mm	2 lm	20 lm	4080 lm
RDP.25	25 mm	2 lm	20 lm	2600 lm
RDP.32	32 mm	2 lm	20 lm	1540 lm

lm = linear meter

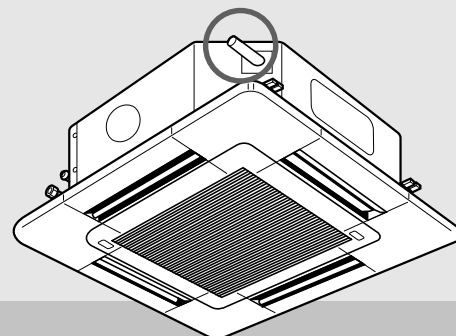

SOME INSTALLATIONS >> We recommend use of non-aggressive installation-grease

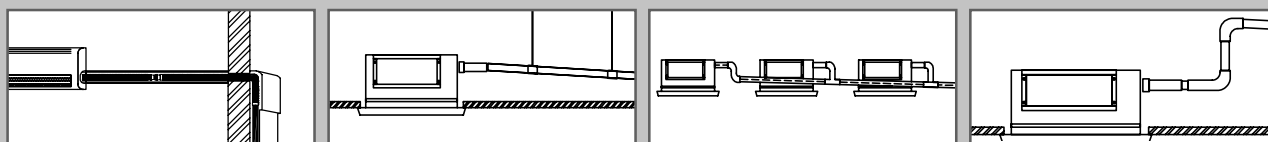

Connecting The Rigid Drain Pipe



REF.	Packing
RDP20-C45	20 pcs 240 pcs
RDP25-C45	20 pcs 200 pcs
RDP32-C45	20 pcs 100 pcs



REF.	Packing
RDP20-XT	20 pcs 240 pcs
RDP25-XT	20 pcs 200 pcs
RDP32-XT	20 pcs 100 pcs



REF.	Packing
RDP20-C90	20 pcs 240 pcs
RDP25-C90	20 pcs 140 pcs
RDP32-C90	20 pcs 100 pcs



REF.	Packing
RDP20-T	20 pcs 160 pcs
RDP25-T	20 pcs 100 pcs
RDP32-T	20 pcs 60 pcs

Drain Pipe Ducts

Connecting The Rigid Drain Pipe



RDP32-3W20

>> Allows to connect 3x 20mm RDP into a collector with exit into 32mm RDP

REF.	Packing	
RDP32-3W20	20 pcs	160 pcs



REDUCER

REF.	Packing	
RDP25-20 RD	20 pcs	400 pcs
RDP32-25 RD	20 pcs	300 pcs



RDP-CLIP

REF.	Packing	
RDP20- CLIP	20 pcs	1920 pcs
RDP25- CLIP	20 pcs	1200 pcs
RDP32- CLIP	20 pcs	900 pcs

Condensation Connection Soft-Rigid

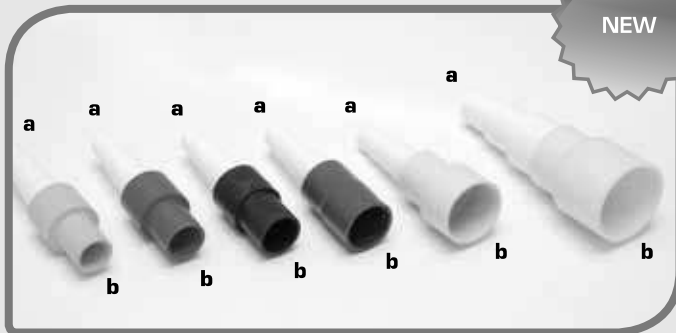

NEW

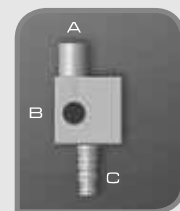
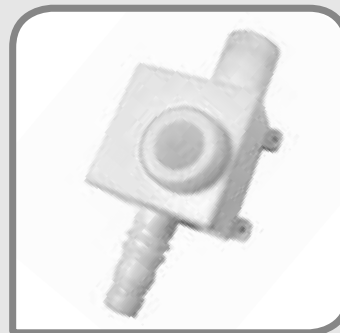

We recommend the use of hose clamps to avoid any leakage



REF.	Ø A - B	Ø C	Packing
SIFON	20	16-18- 20	20 pcs

A, B and C sizes are expressed in mm

REF.	A (for Ø)	Ø B	COLOUR	pcs/bag	
CCSR.16	14-16-18-20	16	Yellow	20 pcs	400 pcs
CCSR.18	14-16-18-20	18	Red	20 pcs	400 pcs
CCSR.20	14-16-18-20	20	Blue	20 pcs	400 pcs
CCSR.25	14-16-18-20	25	Green	20 pcs	400 pcs
CCSR.32	14-16-18-20	32	Grey	20 pcs	400 pcs
CCSR.40	20-25-32	40	Ivory-white	20 pcs	140 pcs



General Conditions

GENERAL CONDITIONS OF SALE

1. The quotations are given without any liability. The sale only has a definitive character after a confirmation in writing on our behalf. Our goods are sold only on these terms, regardless of the buyer's terms.
2. Reception : The goods are transported non-free at buyer's risk. In case of a differing free-delivery, the following conditions are nevertheless applicable. The acceptance of the goods in principle always take place in our warehouses, before departure from the factory. This clause covers the conformity of the goods, concerning the quality and the quantity as well as the dimensions. The loading by the buyer implicates the unconditional and definitive acceptance of the goods. The buyer shall check the goods. In case intermediaries should buy part of the goods, they shall always act as mandataires and on the buyer's account.
3. In case the buyer raises the non-conformity of the goods, before as well as after delivery, the buyer will carry the burden of proof of the non-conformity of these goods.
4. The buyer shall also grant all guarantees to the seller, i.e. the guarantees she will require during the execution of the contract as a security for the payment of the purchase price and for the execution itself. These guarantees are the choice of the seller; bank guarantee, etc. The costs involved are on the buyer's account.
5. The term of delivery is without liability on our behalf and is only a serious estimate. The buyer grants us an additional term of 30 days that only can start at the end of the approximated originally given date of delivery, and after registered letter. Clause for the delivery period. The seller is neither responsible for damage nor for adverse affects resulting from a delay of delivery and / or assembling, in case our firm does not get the raw materials or the products from the subcontractors in time, or in case of strike and under circumstances beyond one's control. In this case, the principal is free to terminate the contract for the delivery that has not been executed, when a notification of thirty days after the date of maturity remained unsuccessful. The seller is never in default without any notification. The goods shall be taken by the buyer within eight days after placing of the goods at the disposal of the buyer. As soon as this term had expired, the invoice will be made out and the amounts due will be payable.
6. The court of law in Doornik will be solely competent to take note of all legal claims. Only the seller can deviate from this clause.
7. All our prices are cash-prices. The invoices shall be paid cash in Mouscron within eight days after delivery. When not paid cash, our prices will be increased by 10 % on account of supplier's credit, with a maximum of €1239,47(50.000 BEF), with or without notification. This is not the case when paid nett, without any discount, within the first month after the date of invoice, or when the seller presents bills, of which she settled the period of currency and which the buyer accepts and honours at the date of maturity.
8. For all sums that are not paid on the date of maturity, a monthly interest of 1,25 % shall be paid as an indemnification. This will happen by right and without summons.
9. At the execution of the order; in accordance with the available drawing or model, made to scale, the indications and modalities given by the buyer are determining for the execution and the conformity, on the responsibility of the latter.
10. In case the buyer fails to grant the demanded guarantees, or in case a value or an invoice is paid too late or is not paid at all on the date of maturity, the deliveries may be stopped either temporary or at the seller's choice even without notification. The seller will be allowed to consider the contract as dissolved by right and to claim immediate payment of all sums due, without taking notice of the granted term, even if it concerns bills of exchange.
11. Termination of the buyer's accountant : for all cases in which the sale is dissolved on the buyer's account, the buyer engages herself to pay a fixed sum to the seller as an indemnification for loss of profit. This sum amounts to 20 % of the value of the goods, of which the sale has been dissolved (art. 1152 - 1184 Belgian Code of Civil Law). However, in case the goods are already in production, the firm is entitled to complete indemnification, but only at her own choice.
12. The delivered goods remain complete property of our firm until complete payment. As the delivery of industrial equipment materials is involved, the seller is entitled to file her invoices in accordance with the legal arrangement, in order to maintain the privilege. In case the buyer does not pay and after notification, and in case this notification remains unsuccessful during eight days, the seller has the right to repossess the delivered goods, even when paid partly. In this case, the repossession will take place at the rate of 40 % of the value and the part that has been paid, will be taken into account. This does not affect the abovementioned articles.
13. All the goods sold are assuredly faultless with regard to raw materials or manufacture, exclusive of any guarantee concerning misuse. The guarantee is valid for 12 months from delivery and confines to free placing of the goods at the disposal of the buyer, instead of the goods recognized as being defective. All other damage or loss is completely beyond the scope of guarantee.
14. Moulds : The parties explicitly agree that the moulds, which are eventually left at the disposal by the purchaser, are pledge of our company. As far as the seller does not meet his obligations, our company has the lien on these moulds, until the purchaser has fulfilled all obligations regarding our company.
15. Our firm reserves herself the right to dispute about a difference in the court of law of her choice, in principle the courts of law of the jurisdiction of our firm's registered office. Yet, our firm also has the right to dispute about differences in other courts of law, such as the courts of law at the buyer's domicile, or the courts of law in Brussels, the Centre of Europe.
16. It has explicitly and herewith in writing been agreed that the goods which have been delivered, remain complete property of our company until full payment, according to the law of 8.8.1997. In case of non payment and after a proof of default hereabout and in case this has remained without any result during eight days, the seller has the right to recollect the goods delivered, and this in kind, even if these would partially have been paid. In case the permission to collect the goods would be refused, our company has the right to demand a penalty for delivery of €247,89 (10.000 BEF) per day of delay.

All pictures in this brochure are for illustration purposes only. Data may change without prior notice.

Certificate of renewable energy

Renewable electricity certified by TÜV SÜD



Electrabel SA certifies that it has bought renewable energy certificates corresponding to 100% of the total electricity consumption of:

Castel Engineering

Rue de la Royenne, 2
7700 Mouscron

Renewable energy bears the TÜV SÜD label. This guarantees that the energy is produced in hydroelectric sites operated by CNR (Compagnie Nationale du Rhône) and SHEM (Société Hydroélectrique du Midi), Electrabel's partners in France, and that the certificates are allocated exclusively to the buyer.

Period of supply:

From 01/01/2009 until 30/06/2011

Brussels, 18/02/2009

Joseph Castermans,
Sales Manager



Castel Engineering Group

CASTEL ENGINEERING BELGIUM - Head Quarters

Rue de la Royenne 84
7700 Mouscron - Belgium
T + 32 (0)56 33 68 40
F + 32 (0)56 33 78 10
info@castel-engineering.com

CASTEL ENGINEERING POLSKA Sp. z.o.o.

Tomaszowice Kol. 126
21-002 Tomaszowice - Polska
T + 48 (0)81 503 28 22
F + 48 (0)81 503 15 55
biuro@castel-engineering.com

CASTEL ENGINEERING ITALIA

T +39 02 33 91 25 06
F +39 02 30 06 77 26
ufficio@castel-engineering.com

CASTEL ENGINEERING PROFILES UK

Unit 4, The Townsend Centre, Blackburn Road,
Houghton Regis,
Beds LU5 5BQ - UK
Tel. / Fax No. +44 (0) 1582 66 33 88
info@castel-engineeringprofiles.com
www.castel-engineeringprofiles.com